

viewmate^x

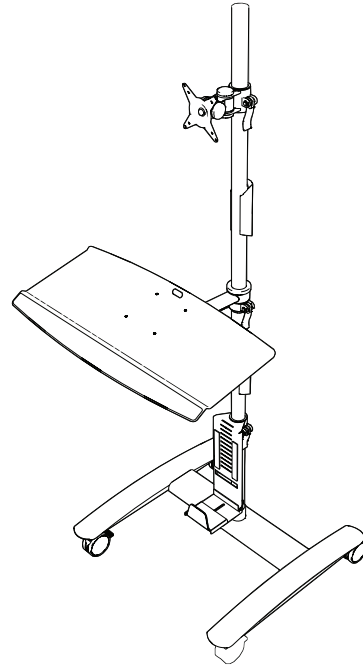

52.702

v1.0

Installation manual/Installatie handleiding
Installations-handbuch/Manuel d'installation
Manuale d'installazione/Manual de instalación
Copyright © 2016 – Dataflex International BV

T +31 180 515444
F +31 180 518540
info@dataflex-int.com
www.dataflex-int.com



+90°/-90°



+90°/-90°



360°



75 x 75/100 x 100

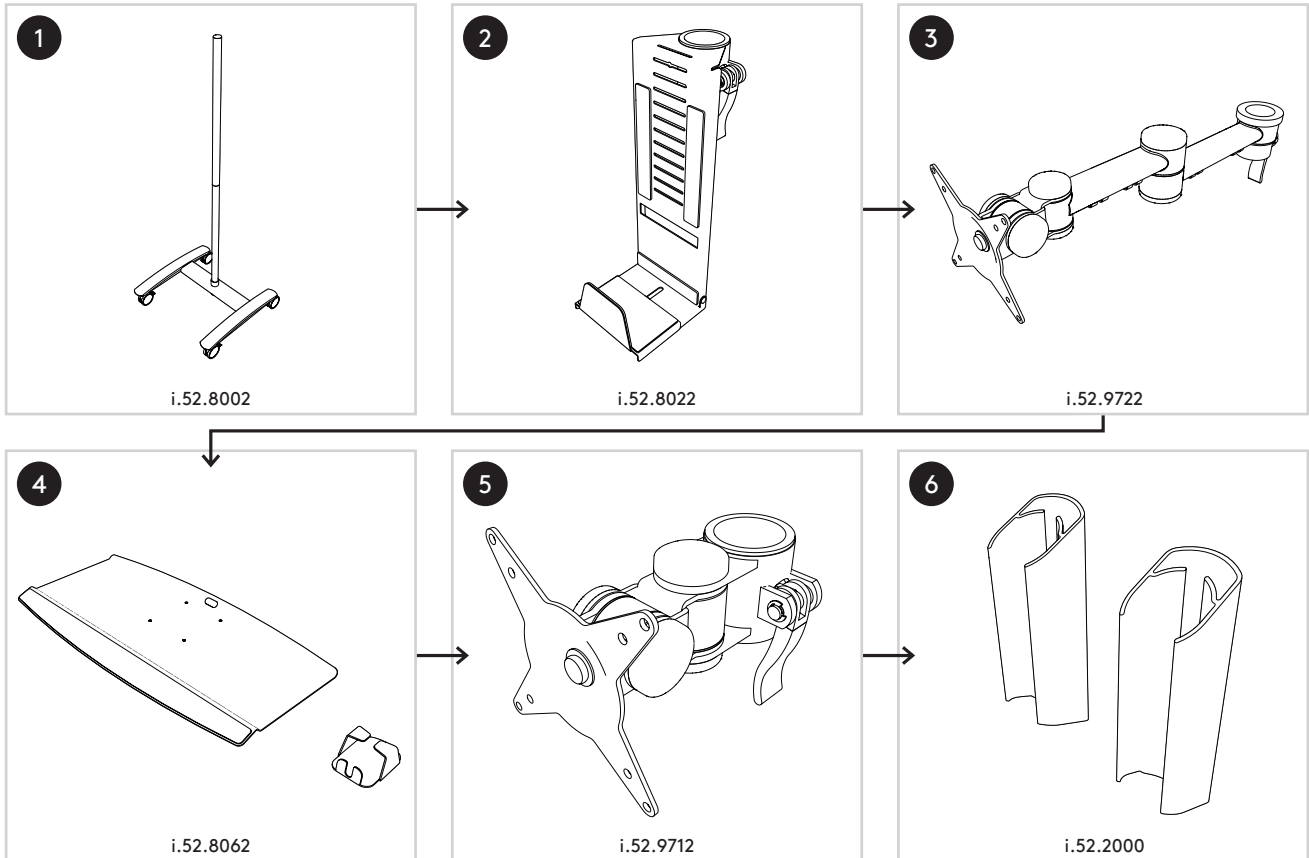

No rights can be derived from this publication/
Aan deze uitgave kunnen geen rechten worden
ontleend/Aus dieser Ausgabe können keine
Rechte abgeleitet werden/Aucun droit ne peut
découler de cette publication/Dal presente
documento non deriva alcun diritto/Del
contenido de esta publicación no podrá
derivarse ningún derecho