



## TABLE OF CONTENTS

SAFETY INSTRUCTIONS .....	2
WHAT DOES MR HANDSFREE BLUE COMPACT INCLUDE? .....	2
DESCRIPTION .....	2
INSTALLATION .....	4
OPERATION .....	6
TROUBLE-SHOOTING .....	20
TECHNICAL PARAMETERS .....	20
BLUETOOTH® .....	21
CARE AND TECHNICAL MAINTENANCE .....	21
GUARANTEE .....	21





## SAFETY INSTRUCTIONS

1. Before starting the installation, make sure that the car ignition is off.
2. Make sure that the operation of the carkit will never influence your safety.
3. Make sure not to damage electrical cables, fuel or brake lines or safety equipment during the installation.
4. Make sure not to impact the steering or braking system or other key systems essential for the proper operation of the car when installing the carkit. Make sure that the deployment of the airbags is not blocked or impaired in any way.
5. The carkit may only be used at an operating voltage of 12V with the minus pole earthed. Failure to observe this requirement may result in damage to the car's electronics system.
6. Do not operate your carkit off the car battery for a long time, i.e. with the engine switched off, as this may cause your battery to run dry.

## WHAT DOES MR HANDSFREE BLUE COMPACT INCLUDE?

### See illustration page

1. Handsfree unit with built-in speaker (**SM2**)
2. Double-sided tape plate for fixation of the handsfree unit
3. Set of screws for fixation of the handsfree unit – 5 pcs.
4. Screen (**D2**)
5. Angular bracket for the screen with corresponding fixing parts and screws
6. Double-sided tape plate for fixation of the angular bracket
7. Double-sided tape plate for fixation of the screen to vertical surfaces
8. Microphone (**M1**)
9. Clips for guiding the microphone cable – 4 pcs.
10. Cable set – Option 1 (**Optional**)
  - 10.1. Adapter for connecting the handsfree unit to the car via the cigarette lighter (**SC3**). It includes a changeable fuse and coil cord.
  - 10.2. Power cable for connecting the handsfree unit to the power supply of the car, the ignition system and for muting the radio (**SC2**). It includes a changeable fuse.
  - 10.3. Contact clips for connecting the SC2 cable to the car circuitries – 5 pcs.
11. Cable set – Option 2 (**Optional, available separately**)
  - 11.1. Mute box (**MB2**)
  - 11.2. Cable **SC5** with ISO sockets for connection to the car circuitries
12. CD with manual and drivers
13. USB reprogramming cable
14. Quick Reference Guide
15. Screw driver
16.  button
17. Central button 
18.  button

## DESCRIPTION

### HANDSFREE UNIT (SM2)

The handsfree unit includes built-in speaker, echo canceller, noise suppressor and Bluetooth® wireless technology, which provides a wireless connection with Bluetooth® mobile phones.





The handsfree unit has the following jacks for connecting external units:

1. Socket for screen (D2) cable.
2. Microphone socket M1.
3. Socket for external speaker connection (3-6W, min 8 Ohm). When the external speaker is connected to socket 3, the built-in speaker is switched off automatically.
4. Socket for SC2, SC3 or MB1 cables connection.

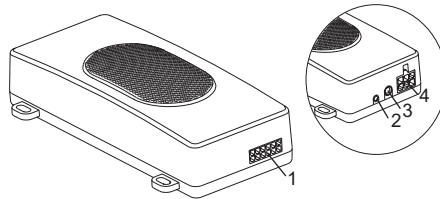

### **SCREEN (D2)**

The screen unit includes:

1. LCD with big symbols and icons.
2. Convenient adjustable fixation system, which allows you to choose the best viewing position of the LCD.
3. Backlight with variable light colors and day and night mode.

**If press:**

- Receiving a call.
- Connecting with paired phone in Hands-free or Headset profile.

**If press and hold:**

- Switching on pairing mode.

---

**If turn Central button to the right or to the left:**

- Navigation in the Menu.

**If press Central button:**

- OK button.
- Opening the menu.

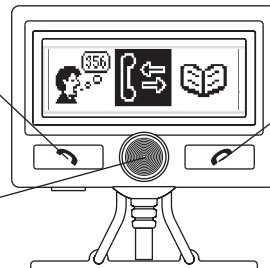

**If press:**

- Ending a call.
- Rejecting an incoming call.
- Returning to the previous level of the menu.
- Deleting input data.

**If press and hold:**

- Returning to Standby mode.

### **MICROPHONE (M1)**

The microphone is developed especially for in-car use. The location of the microphone significantly influences the acoustic quality. For a recommendation on locating the microphone, see the "Installation" chapter.

The microphone has a 2 positional button for adjusting its sensitivity. Press the button on the microphone to increase the volume to the other caller.

### **SYSTEM CABLES SC2 AND SC3 (Optional)**

System cable SC2 connects the handsfree unit with the power supply and the ignition system and is used for muting the radio.

System cable SC3 is used for plug & drive installation. It provides power supply via the cigarette lighter.

Both system cables are supplied with changeable fuses. How to change the fuses is indicated in the illustration below.



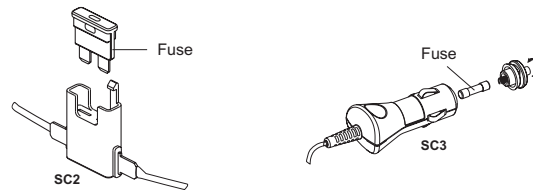

### **SYSTEM CABLE SC5 (Optional, available separately)**

System cable SC5 connects the handsfree unit with the power supply, the ignition system, the mute socket of the car radio and the 2 front car speakers. It includes the mute box (MB2) with relay components and a cable with ISO standard sockets.

Please see the chapter "Installation" where the connection diagram is shown.

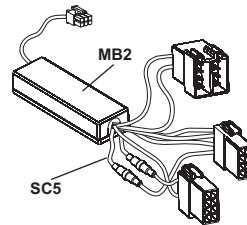

## **INSTALLATION**

### **HANDSFREE UNIT (SM2)**

Search for a location in your car where the handsfree unit fits and where it is comfortable for use. Make sure that the location in your car where you would like to install your handsfree unit is free from dust and dirt.

We recommend mounting the handsfree unit at a less visible position in the car. However, make sure that the unit can provide good acoustic, by directing the speaker in the opposite direction of the microphone and by placing the unit at a distance of more than 1 meter from the microphone.

The handsfree unit can be fixed in 2 ways:

1. Under the dashboard or at any other place in the car using the installation screws.
2. Under the dashboard or at any other place in the car using the double-sided tape plate.

### **SCREEN UNIT (D2)**

Search for a location in your car where the screen unit fits and where it is comfortable for use. Make sure that the location in your car where you would like to install your screen unit is free from dust and dirt.

The screen unit can be fixed in 2 ways:

1. Mount the bracket to the screen unit, using the supplied screws. Then please mount the bracket with the screen unit, using the double-sided tape, on the dashboard or at any other place where it is clearly visible but make sure not to impair control or operation of the vehicle.
2. The most advanced and nice looking option is to place the screen directly on the dashboard, without the bracket, using the double-sided tape.





The cable that comes out of the screen unit is used for connecting the screen unit to the handsfree unit. Make sure that the cable is placed so that it will not be damaged (e.g. not laid under car seats or over sharp edges).

### **MICROPHONE (M1)**

Mount the microphone close to the user's head (30 cm is optimal) and place it so that it is directed towards the mouth. Experience has shown that the best location is near the rearview mirror or to the left of the sun visor. To avoid echo, it is recommended to have a minimum distance of 1 meter between the microphone and the handsfree unit.

Make sure to mount the microphone so that it is not exposed to air streams from the vents. Do not lay the microphone cable in the heating, ventilation or AC systems. Fix the microphone using Velcro.

### **CONNECTING TO THE POWER**

There are 3 ways of connecting the Blue Compact to the car's electronic system:

1. Plug & drive connection: Via the adapter for the cigarette lighter (SC3) (*Optional*).
2. Built-in connection: Immediately to the car's electronic system via system cable SC2 (*Optional*).

The wires of cable SC2 are color-coded. They are listed in Table 1 in column A and each wire should be connected to the corresponding item listed in column B.

**Table 1**

A	B
Red wire	The + voltage of the car's power supply
Black wire	The negative GND connection
Blue wire	Ignition
Brown wire	Used for Car Radio Muting (CRM) and has to be connected to the car radio (Mute)

- To avoid distortions, make sure that the cables are laid far away from the electronic systems of the car.
- Connect the wires with the contact clips. Put the car wire in the through groove of the clips and the cable wire in the groove with the confining rib.

#### **Attention!**

If there is no "Ignition" wire or if it is unavailable, you should connect the blue cable wire to the red wire of the handsfree unit and the red cable wire to the "Continuous" wire of the car which keeps the voltage when ignition is turned off. In this case, the phone call will not be disconnected if the ignition is turned off.

### **CAR RADIO MUTING (CRM)**

The Blue Compact allows muting your car radio when there is an incoming call.

- Check the user's manual of your car radio and ensure that it has a Mute function. If additional settings have to be set from the car radio menu, make sure that they are done correctly.
  - Remove the control panel of the car radio.
  - Remove the decorative panel and take the car radio out of the sleeve using the handles. Disconnect the car radio plug.
  - Connect the wires of the mr Handsfree Blue Compact to the corresponding wires of the car radio according to Table 1. Use the contact clips for the connection.
  - Restore the connection and installation of the car radio.
3. Professional built-in connection: Immediately to the car's electronic system via system cable SC5 (*Optional, available separately*).
    - Disconnect the car radio and power leads.
    - Join the cable according to the connection diagram shown below. If the car radio has a mute jack, connect the brown





wire of the SC5 cable to one of the "mute in" jacks (1,2 or 3). Refer to your car radio manual to determine the position of the mute jack.

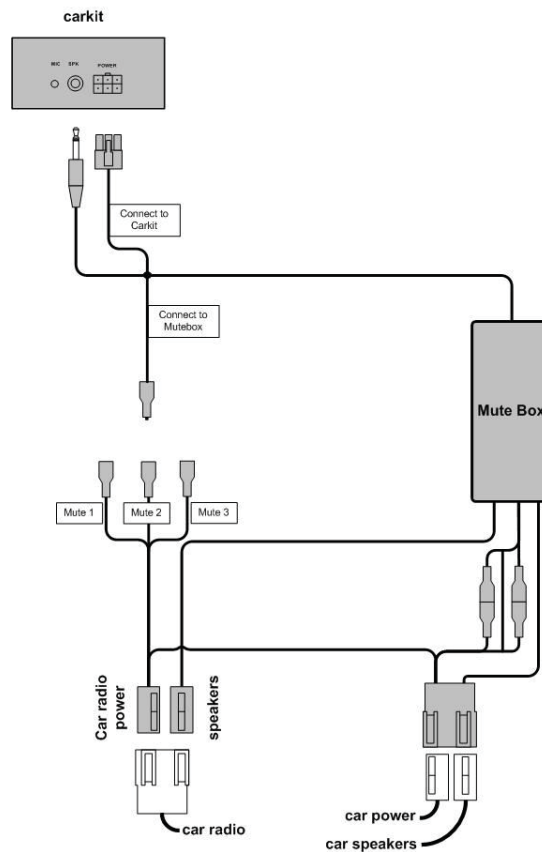

## OPERATION

Since devices with Bluetooth® technology communicate through radio waves, your carkit and your mobile phone do not need to be in direct line-of-sight. The 2 devices only need to be within a maximum of 10 meters of each other, so you don't need to take your phone out of your pocket or bag to make and receive calls via the carkit.





Since Bluetooth® phones produced by different manufacturers provide various functionalities; some functions described in this user's manual could be different or may not be available.

### **SWITCHING ON/OFF**

If the mr Handsfree Blue Compact is connected to the power via the adapter with cable SC3, you can switch on the unit by clicking the adapter into the cigarette lighter.

If the mr Handsfree Blue Compact is connected to the power via cable SC2 or SC5, the unit will switch on automatically when you turn the ignition key on.

Mr Handsfree Blue Compact will turn off automatically when the ignition is off.

### **MENU STRUCTURE**

All functions of the unit are grouped in the menu.

- To access the menu, press the central button once. The menu of quick access appears on the display.



- To move in the menu, turn the central button to the left or to the right.

The menu structure is shown below:



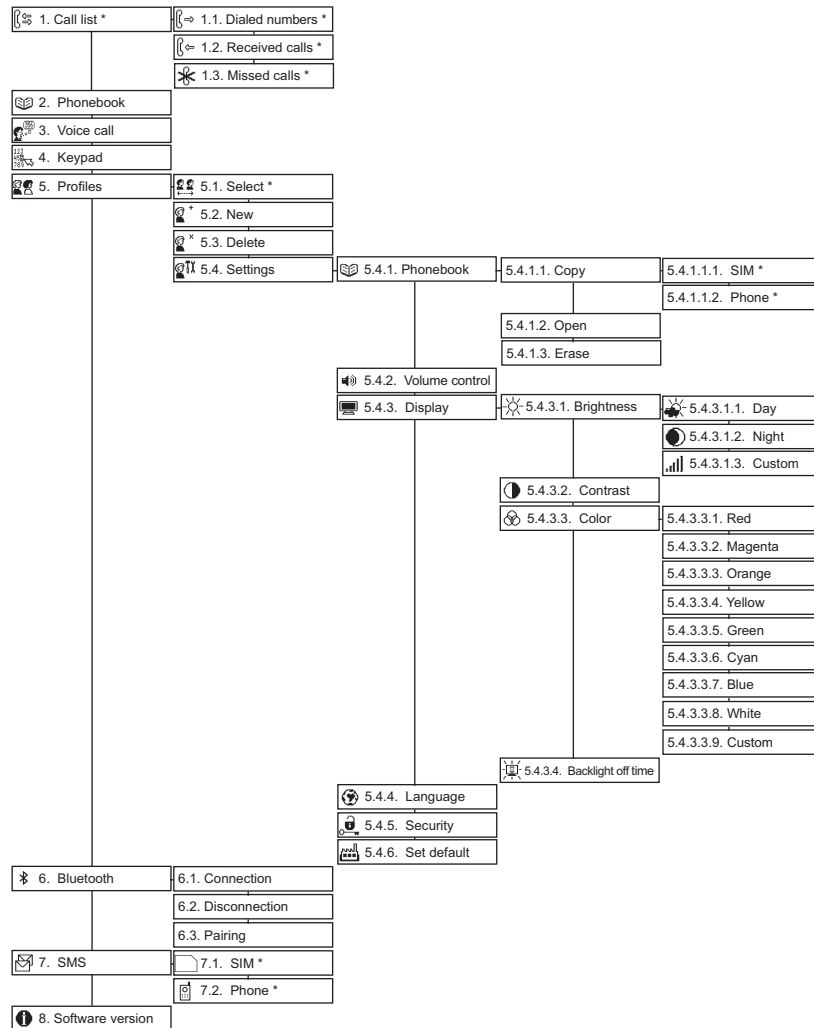

\*These menus will only be visible when this information is available in your carkit/mobile phone.





## USER PROFILES

The Blue Compact supports a multiple user profiles structure. The maximum quantity of user profiles is four. Every user can copy and keep in the carkit memory his phonebook, call list and configuration settings of the device. The name of each profile is identified according to the Bluetooth® name of the corresponding mobile phone. If no phone is paired with the carkit, the pairing operation has to be done first.

As soon as the carkit is switched on, the latest profile is activated automatically and the carkit is making an attempt to connect with the corresponding phone. If the last paired phone is not found, the carkit will switch to Standby mode. For your security, every profile can be protected by a PIN code (up to 4 digits). You can read more detailed information about the profiles in the chapter "Profiles".

## PAIRING, CONNECTION AND DISCONNECTION

### **A. PAIRING**

- For pairing the mr Handsfree Blue Compact with your Bluetooth® mobile phone, you should go to **Bluetooth® ⇨ Pairing** and then press . Now your Blue Compact is in registration mode. The corresponding message appears on the display and a confirmation tone will be heard.





- Activate the Bluetooth® function in your mobile phone.
- Search for available Bluetooth® devices by entering the corresponding submenu of the phone. Your phone will find all Bluetooth® devices within 10 meters distance and display them as a list.
- Select "Blue Compact" from the list.
- Enter the passkey "0000". "Pairing OK" will appear on the display and the device will return to Standby mode. "Blue Compact" will be stored in the list of paired devices in your phone.

#### **Note:**

- **If necessary, the pairing mode could be activated by pressing and holding the  button on the screen unit for more than 5 seconds.**
- **If you want to pair a new phone with the Blue Compact and store the currently paired phone in the carkit's memory, you should create a new user in the menu 5.2 (New user).**



### **B. CONNECTION**

In some cases the device could be disconnected from your phone. For example, if the Blue Compact was switched off. To restore the connection between the Blue Compact and your phone:

- Switch on the power and the connection will be restored automatically; OR
- Use the central button to go to **Bluetooth® ⇨ Connection** and press . "Connection" will appear on the display; OR
- In Standby mode, press the  button on the screen unit.

### **C. DISCONNECTION**

Sometimes you need to disconnect your phone from the Blue Compact. For example, if the phone should communicate with another Bluetooth® device. To disconnect the Blue Compact and your phone:

- Switch off the Blue Compact; OR
- Go to **Bluetooth® ⇨ Disconnection** and press ; OR
- Press and hold the  button on the screen unit for 5 seconds; OR
- Take the phone more than 10 meters away from the Blue Compact; OR
- Disconnect the Blue Compact and the phone through the phone's menu.





**Note:**

If the Blue Compact and your phone were disconnected and you want to reconnect them it is not necessary to pair these 2 devices again. Restoring of the connection will be performed without asking for the access code.

**FUNCTIONS**

**1. CALL LIST**



You can use this feature to review the call lists and dial the numbers the same way as you do with your mobile phone. The call lists are stored in the carkit memory even if you switch off the power. There are three call lists for every profile: received calls, dialed numbers and missed calls. Each call list can keep up to 32 numbers.

In every profile you can keep your call lists:

- Incoming calls – up to 32 numbers
- Outgoing calls – up to 32 numbers
- Missed calls – up to 32 numbers

**Remark:**

- Only the calls that were made with the carkit will be stored in the call list memory.
- These lists will only be shown when there are numbers available in these lists.

**2. PHONEBOOK**



You can use this item to review your phonebook and quickly search for a necessary phone number by name.

You can use the phonebook for dialing out. The records of the phonebook are displayed in alphabetical order in the display. The Blue Compact phonebook can store up to 440 records for every profile.

For a quick search of the desired name, find its first letter with the cursor using the central button and press to see the list of the names. Select the desired name or number and press to see the details or press to dial the number.

For a detailed description of the phonebook operation please refer to the chapter "Phonebook settings".

The phonebook copying process is described in chapter 5.4.1.

**3. VOICE DIALING**



If your phone supports voice dialing and there are saved voice tags (names), you can use this function via the Blue Compact.

**4. LCD KEYPAD**





By using the LCD keypad and the central button you can dial out any number.

- Press to open the menu.
- Turn the central button to the left or the right to move and choose a digit on the display.
- Press to confirm or press to delete a digit.
- Press to dial the number.

## 5. PROFILES



The maximum quantity of user profiles is four. Every user can copy and keep in the carkit memory his phonebook, call list and configuration settings of the device. The name of each profile is identified according to the Bluetooth® name of the corresponding mobile phone. If no phone is paired with the carkit, the pairing operation has to be done first. As soon as the carkit is switched on, the latest profile is activated automatically and the carkit is making an attempt to connect with the corresponding phone. If the last paired phone is not found, the carkit will switch to Standby mode.

### 5.1. Select



Use this item to select the necessary profile by name to activate it. This item is only available when various profiles have been created. If the necessary profile is protected by a PIN code, the digital keypad will appear and you have to enter the PIN code accordingly (up to 4 digits). If the PIN code is correct, you will get access to your phonebook and settings.

### 5.2. New



Use this item to create a new profile.

- Press to open the menu.
- As soon as this item is selected, the Blue Compact will ask you to enter the PIN code for the new profile and the digital keypad will appear.
- You can enter the PIN code (up to 4 digits) and press to confirm.
- If you decide not to use a PIN code, just press .
- To activate the pairing procedure, press and pair your mobile phone according to the instructions.
- The name of the profile is identical to the Bluetooth® name of your mobile phone.
- If the pairing procedure passed successfully, the carkit is connected to your phone automatically.

### 5.3. Delete







Use this item to delete unnecessary profiles. You can only delete the active profile.

- Press to open the menu.





- Select the unnecessary profile that you would like to delete from the list and press .
- If this profile is protected by a PIN-code, you will be asked to enter it.
- Enter the PIN-code and press .
- Press  to confirm and delete the profile or press  to cancel the operation.

**Note:**

If you forgot the PIN-code, you can use the master PIN-code '8888'. This master PIN-code can only be used for deleting the profiles.

## 5.4. Settings



Use this item to choose your individual settings for the Blue Compact.

### 5.4.1. Phonebook settings





#### 5.4.1.1. Copy

Use this item to copy the phonebook of your phone to the Blue Compact phonebook. The maximum number of phonebook records is 440 for each profile.

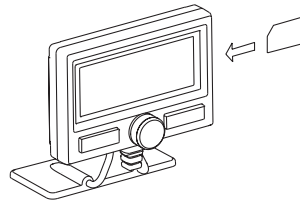
Since not all Bluetooth® phones support phonebook copying using Bluetooth®, you can also use the built-in SIM card reader to download your phonebook data in the Blue Compact memory. To copy the phonebook using the SIM card reader, please insert the SIM card into the SIM card holder according to the picture. Make sure that you push the card deep enough, until it clicks into place.



- If the Blue Compact already has some phonebook records in the current profile, a warning message will appear.
- Press  to confirm the phonebook erasing or press  to cancel.
- If the SIM card is PIN code protected, the screen keypad will appear:

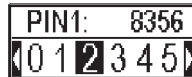

- Enter the PIN code by turning the central button to the left or the right to select digits.
- Press  to confirm your choice. The selected digits will appear on the top part of the display.





- To delete an incorrect digit, press or hold for a few seconds to delete all digits.
- Press to confirm the PIN code.
- The phonebook copying will start accordingly. The existing phonebook, stored in the Blue Compact, will be erased automatically.
- If your SIM card is not PIN code protected, the phonebook copying process will start automatically.
- As soon as the phonebook copying process is finished, you can remove the SIM card from the holder. To release the card from the holder, you should press it.
- Insert the SIM card in your mobile phone and switch it on.
- Activate the menu of the Blue Compact and select **Bluetooth®** ⇨ **Connection**.
- Press to confirm your choice.
- The connection should be restored.

#### 5.4.1.2. Open

Use this item to view the phonebook records.

#### 5.4.1.3. Erase

Use this item to delete all the phonebook records.

#### 5.4.2. Volume control



This item is used for setting the desired volume of the speaker of the Blue Compact in Talk mode and the volume of the incoming call ringer.

- Press to open the menu.
- Turn the central button to the left or the right to set the volume and press to exit the menu. The volume setting has now been saved.

#### 5.4.3. Display settings



##### 5.4.3.1. Brightness

Choose this menu item for setting the brightness of the display backlight.



- Press to open the menu.
- Choose "Day" for the brightest backlight: press to confirm and press to exit the menu.
- Choose "Night" for a darker backlight: press to confirm and press to exit the menu.

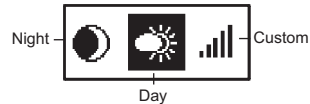



- Choose "Custom" if you want to tune the brightness:
    - o Press to enter the submenu.
    - o Turn the central button to the left or the right to choose the desirable brightness.
    - o Press to confirm or press to restore the previous setting of the brightness.
    - o Press to exit the menu.
- The custom setting of brightness has 16 levels. Level 0 switches the backlight off, level 15 is the maximum.

#### 5.4.3.2. Contrast

Use this menu item for setting the contrast of the display.



- Press to open the menu.
  - Turn the central button to the left or the right to set the desirable contrast.
  - Press to confirm or press to restore the previous setting of the contrast.
  - Press to exit the menu.
- The contrast has 16 levels. Level 0 is the minimum, level 15 is the maximum.

#### 5.4.3.3. Color

Choose this menu item for setting the color of the display backlight.



- Press to open the menu.
- Choose one of the available colors:
  1. Red
  2. Magenta
  3. Orange
  4. Yellow
  5. Green
  6. Cyan
  7. Blue
  8. White
  9. Custom
- Choose the menu item "**Custom**" to tune the color of the backlight smoothly.



- Turn the central button to the left or the right to choose the desired color for tuning: R, G or B.
- Press to activate.
- Turn the central button to the left or the right to tune the level of the desirable color.
- Press to confirm or press to restore the previous setting of the color.



#### 5.4.3.4. Backlight off time

Choose this menu item to set the time after which the backlight will be switched off.



- Press to open the menu.
- Turn the central button to the left or the right to set the timer. If you choose “**Always on**”, the backlight will not be switched off. Timer steps are 10 seconds, maximum is 1 minute.
- Press to confirm or press to restore the previous setting and exit the menu.

#### 5.4.4. Language



- Press to open the menu.
- Choose one of the available languages (English, Russian, Dutch ...).
- Press to confirm or press to restore the previous setting and exit the menu.

#### 5.4.5. Security

Choose this menu item to activate or deactivate the security PIN code for the current profile.



- Press to open the menu.
- The digital keypad will appear.
- Enter the PIN code by turning the central button to the left or the right to select digits.
- Press to confirm your choice. The selected digits will appear on the top part of the display.
- To delete an incorrect digit, press .
- Press to confirm the PIN code.

#### Note:

If you don't want to enter the secure PIN code, you should not enter the code. Just press the button or clear all digits to deactivate the code. Press to confirm.

#### 5.4.6. Set default



With this item you can restore the factory settings of the Blue Compact.

Parameter	Value
Brightness	15/15 (max)
Contrast	8/15 (mid)
Backlight Color	White





Language	English
Backlight off time	10 sec

- Press to open the menu.
- “Set default?” will appear on the display. Press to confirm or press to cancel.

## 6. BLUETOOTH



### 6.1. Connection

Use this item to connect the Blue Compact and your mobile phone.

### 6.2. Disconnection

Use this item to destroy the connection between the Blue Compact and your mobile phone.

### 6.3. Pairing

Use this item to pair the Blue Compact and your Bluetooth® mobile phone.

## 7. SMS



With this item of the menu you can copy received SMS from your phone's memory or SIM card (up to 20). You will see the first word of each message. By clicking these words, you will open the message and see more details.

### Note:

**This function is not supported by some mobile phones.**

### Overview list of SMS

- To view the SMS list in Standby mode, press and choose the item “SMS” .
- Press again. The SMS submenu will be displayed.
- Select from which source you want to see the SMS: from the phone or from the SIM card memory and press .
- The list will be displayed.
- Choose an SMS and press to view it.
- Press to see the telephone number/name of the SMS sender and the message receiving date and time.
- Press to dial this telephone number.
- Press to exit the SMS viewing mode.

## 8. SOFTWARE VERSION



- Press to open the menu. The number of the software version will appear on the display.
- Press to exit the menu.





## **MAKING CALLS**

### **1. STANDBY MODE**

In Standby mode the display shows the current parameters of your phone:

- Signal strength of the cellular network at the current location. The higher the bars, the stronger the signal. The number of bar-segments may differ slightly from your phone due to Bluetooth® implementation for this software.
- Capacity of the battery. The higher the capacity, the more bars. If the battery is almost discharged, the icon will flash. If the phone is in charging mode, the charger icon will appear near the battery icon.
- The Bluetooth® name of the connected mobile phone.
- If the Bluetooth® connection is activated, there will be a "Car" icon on the display.



### **2. VOICE DIALING**

Before using this function make sure that you have saved voice tags for voice dialing in your phone.



- To activate voice dialing, press and select the item "Voice call" in the menu.
- Press .
- The below picture will appear on the display.



- After the beep, say the tag. (This beep will be sent out by your mobile phone.)
- The Blue Compact will activate the corresponding tag from the phone memory and dial the number.

### **3. DIALING FROM THE PHONEBOOK**

You can dial a number from the phonebook stored in the Blue Compact memory.



- In Standby mode, press to enter the menu and select "Phonebook" .
- Press .
- The below picture will appear on the display.





- Turn the central button to the left or the right to scroll through the alphabet and select the first letter of the desired name.





- Press .
- The below picture will appear.



- Turn the central button to the left or the right to scroll through the phonebook list.
- Press  to view detailed information of the record (name and phone number).
- Press  to return to the phonebook.
- Press  for dialing.



**Note:**

The line with the letters only contains the letters corresponding to the phonebook records.



#### 4. DIALING FROM THE LCD KEYPAD

You can use the LCD keypad to enter a number.

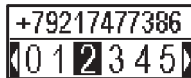

- In Standby mode, press  to enter the menu and select the item "Keypad" .
- Press .
- The following keypad will appear on the display:



- Turn the central button to the left or the right to select digits.
- Press  to confirm the choice. The selected digits will appear on the top part of the display.
- To delete an incorrect digit, press .
- Press  to dial the number.

#### 5. REDIAL

Redial is done from the call lists. By selecting the outgoing call list, you can redial the last numbers that have been dialed with the Blue Compact after switch on.

- In Standby mode, press  two times.
- Three lists will appear on the display:



You can choose the desirable number from every list:

- Outgoing calls
- Incoming calls
- Missed calls

**Remark:**

These lists will only be shown when there are numbers available in these lists.





The maximum capacity of each list is 32 records. If a number was stored in the phonebook, the name will be displayed.

- Turn the central button to the left or the right to move from one list to another.
- Press to enter into the selected list.
- Turn the central button to the left or the right to scroll through the list.
- Press to dial the number.
- Press to exit the menu.

## 6. DURING A CALL

During a call, the display shows the following information:

1. Telephone number (if your mobile phone supports Caller ID)
2. Name (if this number has been saved in the phonebook of your carkit)
3. Duration of a call
4. Icons, which show the left and the right button destination

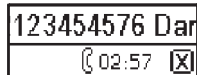

- During a call you can adjust the volume by turning the central button to the left or the right.
- Transfer the call from the Blue Compact to the phone by pressing 2 times.
- Transfer a call from the phone to the Blue Compact through the corresponding item in the phone's menu.
- If you need to dial the DTMF command, press and select the menu item "DTMF" . Press to enter and the screen keypad will appear.
- Turn the central button to the left or the right to select the digits.
- Press to confirm your choice. The selected digits will appear on the top part of the display.
- To delete an incorrect digit, press .
- Press to send the DTMF command.

### Second incoming call

- The caller information appears on the display.



- Press to receive the second incoming call.
- The first call will be put on hold.
- Press to end the current call.

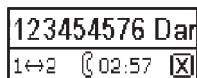

- To switch between the calls, press .

## 7. ENDING A CALL

Press to end a call.

## 8. ANSWERING A CALL

If there is an incoming call, the number of the caller will appear on the display.



If the name and number are stored in the phonebook of the Blue Compact, the name will appear on the display as well.

☎→ Daniela  
+78121234576

Press to answer a call.

### 9. REJECTING A CALL

If you do not want to receive a call, press .

## TROUBLE-SHOOTING

Problem	Reason	Elimination
The device does not work. The green LED of the power adapter is off.	<ol style="list-style-type: none"> <li>1. The cigarette lighter jack is damaged.</li> <li>2. No contact between the power adapter and the cigarette lighter jack.</li> <li>3. 1.5 A fuse in the power adapter is burned.</li> <li>4. The power adapter is damaged.</li> </ol>	<ol style="list-style-type: none"> <li>1. Check if the cigarette lighter functions normally.</li> <li>2. Clean the contact of the cigarette lighter jack and the power adapter.</li> <li>3. Change the fuse.</li> <li>4. If items 1-3 did not help, apply to a service center.</li> </ol>
The device does not work. It is connected to the car radio through the adapter. The car radio works.	<ol style="list-style-type: none"> <li>1. No contact between the wires.</li> <li>2. Car radio wires have a smaller diameter than necessary (with cross section area less than 0.75mm<sup>2</sup>).</li> <li>3. 1.5 A fuse in the adapter is burned.</li> </ol>	<ol style="list-style-type: none"> <li>1. Check the contact in the connection points.</li> <li>2. For the connection, use contact clips which correspond to the standard of your car or another suitable type of connection.</li> <li>3. Change the fuse.</li> </ol>
A caller does not hear you.	<ol style="list-style-type: none"> <li>1. The microphone is disconnected.</li> <li>2. The microphone's cord is damaged.</li> </ol>	<ol style="list-style-type: none"> <li>1. Check the connection of the microphone and the microphone jack of the handsfree unit.</li> <li>2. Apply to a service center.</li> </ol>
The device is connected to the car radio, but does not mute it during a call.	The car radio Mute function needs additional settings to be activated.	Check your car radio user's manual and make the necessary settings.

## TECHNICAL PARAMETERS

### Car battery voltage

12.6 V (10.8 – 13.5)  
with negative pole of GND

### Consumption current

In Talk mode – 0.8 A (max)  
In Standby mode – 50 mA





**Fuse**  
1.5 A

### **SYSTEM CABLE SC2**

- Red: +12B
- Black: GND
- Blue: ignition, ACC/IGN
- Brown: Mute function of car radio. In Talk mode voltage switches from +12 V to 0 V.

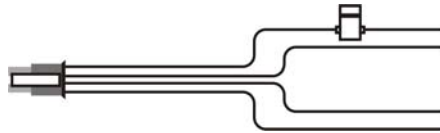

## **BLUETOOTH®**

The Bluetooth® word mark and logos are owned by the Bluetooth SIG, Inc. and any use of such marks by TE-Group NV is under license. Other trademarks and trade names are those of their respective owners.

## **CARE AND TECHNICAL MAINTENANCE**

The Blue Compact is a product of superior design and craftsmanship and should be treated with care. The suggestions below will help you to fulfill any guarantee obligations and to enjoy this product for many years.

- Keep the device and all its parts dry. Precipitation, humidity and all types of liquids or moistures can contain minerals that will corrode the electronic circuitry.
- Do not store the device in hot areas. High temperature can shorten the life of electronic devices and warp or melt certain plastics.
- Do not store the device in cold areas. When it warms up (to its normal temperature), moisture can form inside, which may damage electronic circuitry boards.
- Do not attempt to open the device. Non-expert handling may damage it.
- Do not use harsh chemicals, cleaning solvents or strong detergents to clean the device.

## **GUARANTEE**

Mr Handsfree is a registered trademark of TE-Group NV.

The mr Handsfree brand stands for superior product quality and outstanding customer service. That is why mr Handsfree warrants this product against all defects in material and workmanship for a period of **three (3) years** from the date of original purchase of the product.

The conditions of this limited guarantee and the extent of responsibility of mr Handsfree under this limited guarantee are as follows:

- This guarantee is limited to the original purchaser of the product and is not transferable to any subsequent purchaser/end user.
- During the limited guarantee period, the sole responsibility of mr Handsfree will be limited to repair or replace, at its option, any defective parts of the product if this is needed because of malfunction or failure under normal use and conditions. No charge shall be made to the customer for parts and/or repair labor.
- The product must be shipped to an authorized service center in its original and complete packaging, with transportation charges prepaid. Mr Handsfree will not assume responsibility for any losses or damages during transportation.
- To obtain repair or replacement within the terms of this guarantee, the customer must provide (a) a proof of purchase (e.g. dated bill of sale); (b) a written specification of the defect(s); (c) a return address and phone number.





- This limited guarantee does not cover and is void with respect to the following:
  - (a) Products which have been subjected to improper installation, unauthorized repair, improper maintenance, unauthorized modifications or other acts which are not the fault of mr Handsfree;
  - (b) Products which have been subjected to misuse, abuse, neglect, improper handling and storage, an accident or physical damage;
  - (c) Products which have been subjected to fire, water, excessive humidity, sand, dirt, extreme changes in temperature or other conditions which are beyond the control of mr Handsfree;
  - (d) Products which have been used with non-mr Handsfree approved accessories;
  - (e) Products which have the serial number altered, defaced or removed;
  - (f) Products which have been opened, altered, repaired or modified by any unauthorized service center.
- Excluded from any guarantee are consumable items which may need replacing due to normal wear and tear, such as batteries, headset ear cushions, decorative parts and other accessories.
- This limited guarantee gives you specific legal rights, and you may also have other rights which vary from country to country.

